

VPM480 Cleanroom

Dimensional drawing

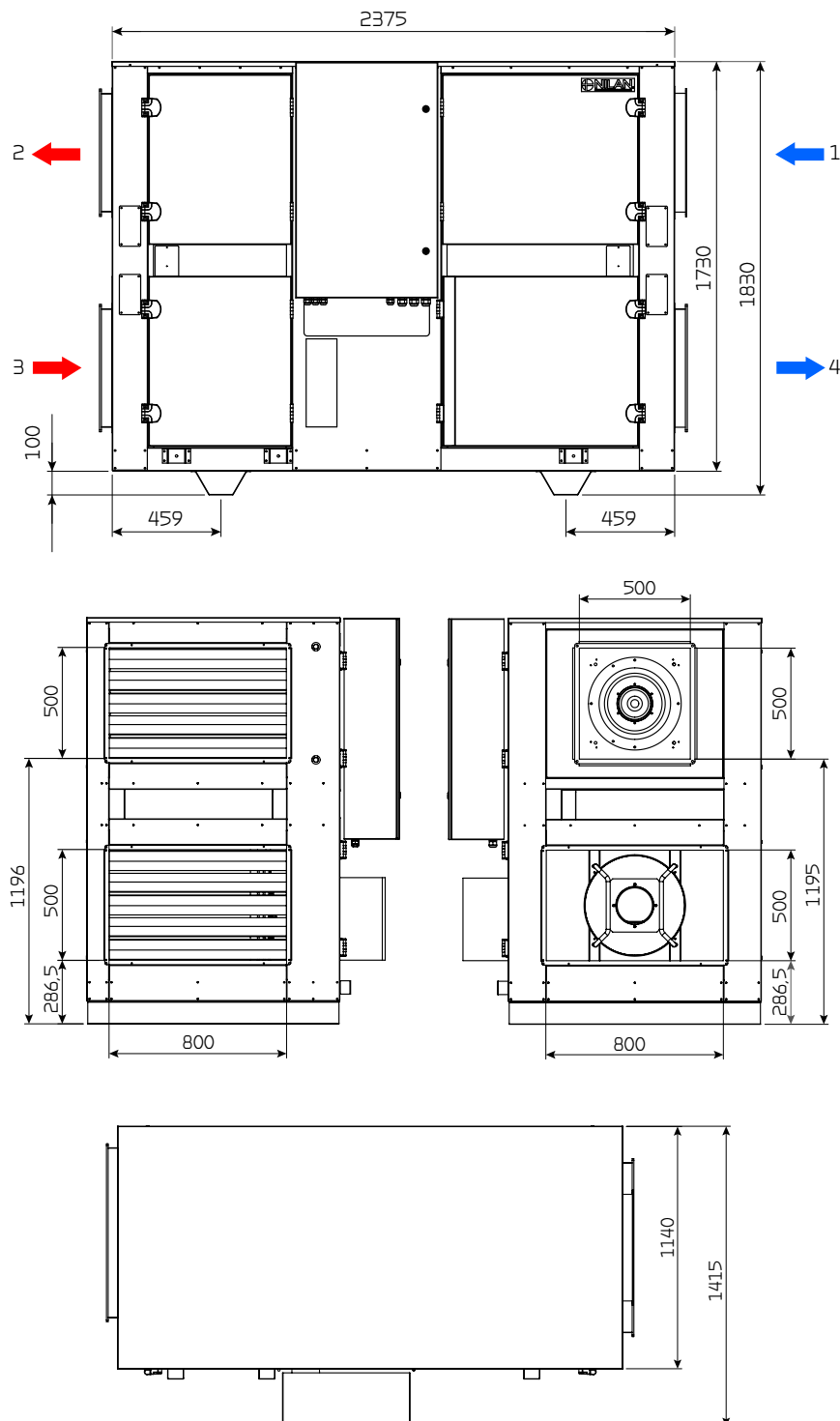

- Connections:**
1. Outdoor air
 2. Supply air
 3. Extract air
 4. Discharge air